

Hello,  
I've arrived!

Now that I'm here you are only one  
flat-pack away from transforming  
your home.

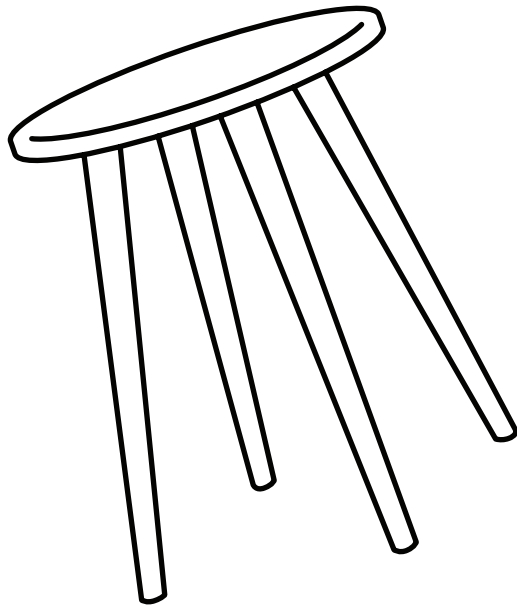
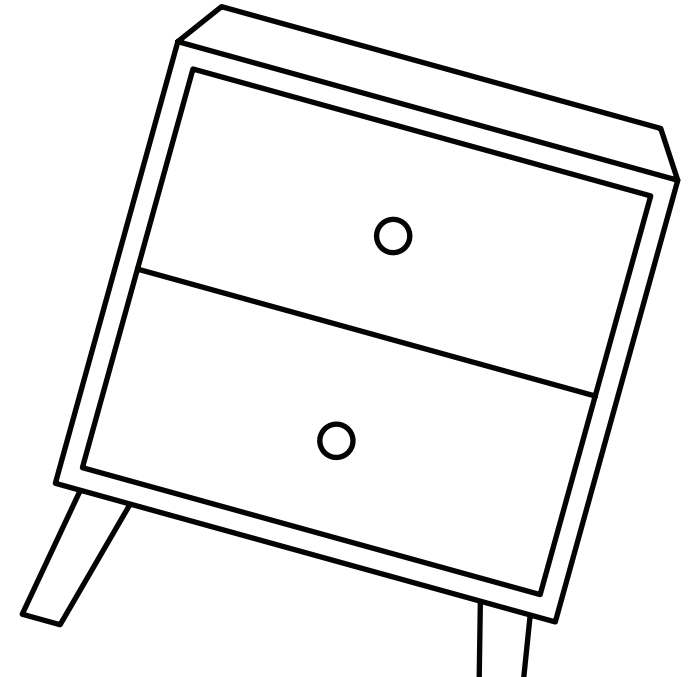

**Mocka.**

# Thank you for supporting us.

We believe design belongs to everyone. From materials and processes to safety testing, production and delivery, we are passionate and committed to bringing you the best possible product so you can create beautifully functional spaces to feel comfortably you.

Here are a few assembly tips before you get started:



## Make Time

The first step to all seamless assembly is taking a moment to carefully read through the instructions—you are already on your way to creating a beautifully functional space!



## Set The Mood

Put on your favourite playlist, order that pizza and pour yourself a drink to get in the mood!



## Tool Check

Layout the instructions, screws and panels to check you have everything you need. A blanket or soft floor rug will help protect your new favourite item from scratches and a drill will speed up the assembly too!



## Room Reveal

You did it! Take a step back and enjoy the moment. Don't forget to recycle any packaging and share a pic of your room reveal - we love seeing how you transform your home! Tag us @mockaaustralia/@mockaanz

Happy flat-packing!

*The Mocka Team*

# Hector Occasional Chair

Thank you for purchasing the Hector Occasional Chair. Please follow these assembly instructions in detail.

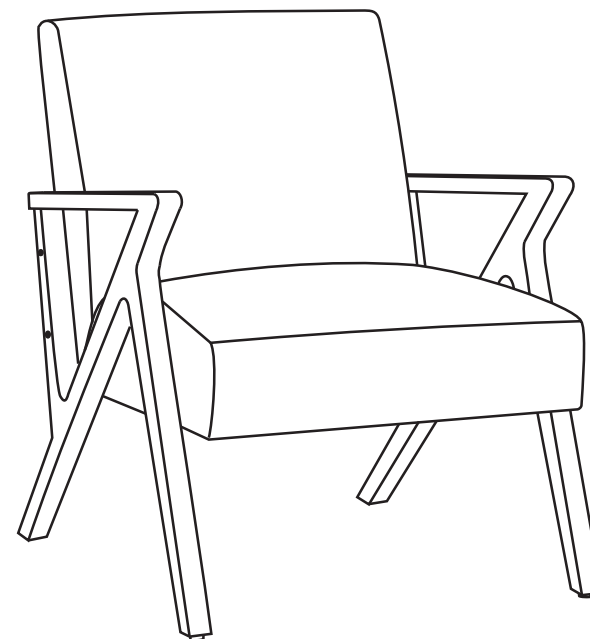
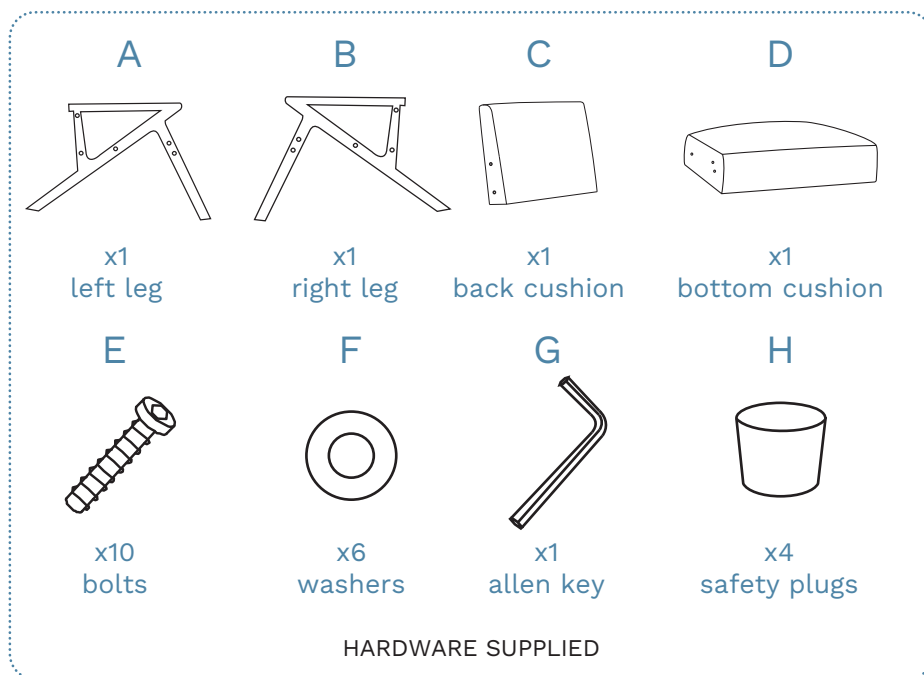

# Hector Occasional Chair

1

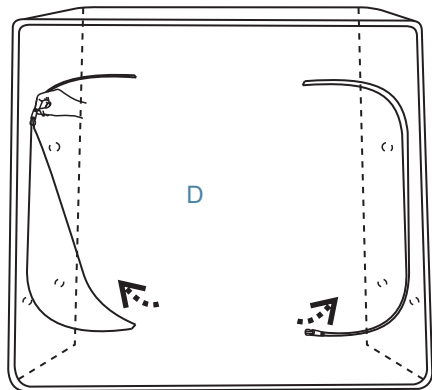

Unzip cushion (D) as shown.

2

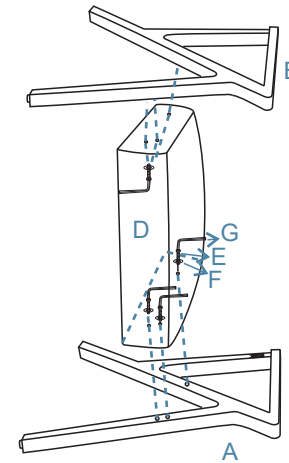

Attach left leg (A), right leg (B) to cushion (D) and secure with 6 x washers (F) and 6 x bolts (E). Tighten with an Allen Key (G).

# Hector Occasional Chair

## 3

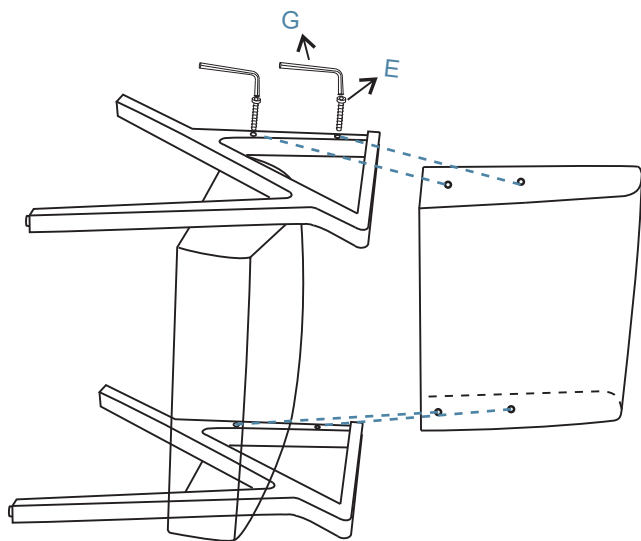

Attach 1 x back cushion to assembled frame as shown and secure with 2 x bolts (E). Tighten with an Allen Key (G).

## 4

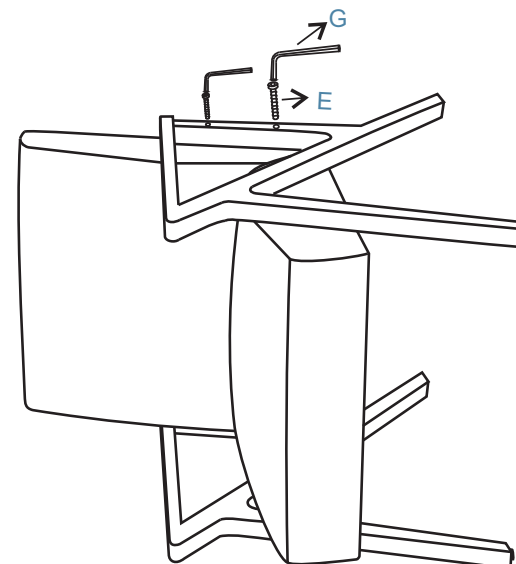

Attach 1 x back cushion to assembled frame as shown and secure with 2 x bolts (E). Tighten with an Allen Key (G).

# Hector Occasional Chair

## 5

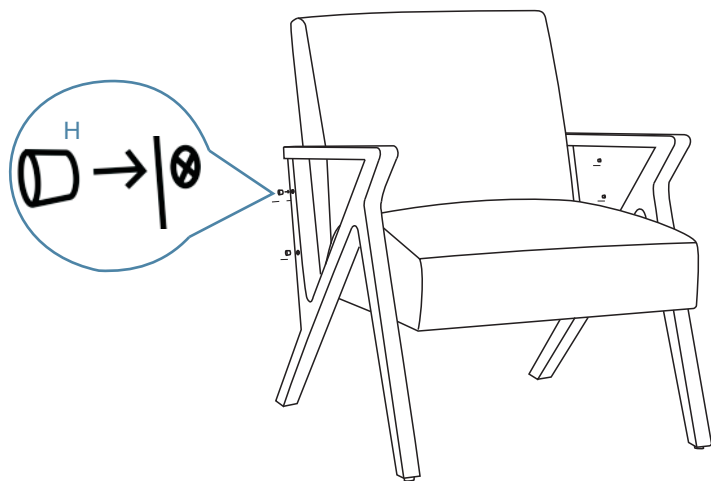

Attach 4 safety plugs (H) over the bolts as shown.

## 6

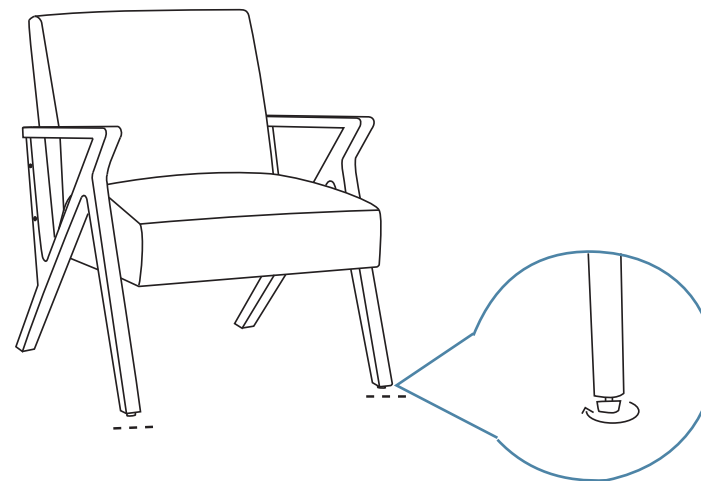

Once assembled lift furniture into place, do not drag. Ensure unit is balanced and steady before use. You're done, enjoy!